



# GTR 225/225A/225B

## Pilot's Guide



## **COPYRIGHT & TRADEMARKS**

© 2012-2020 Garmin Ltd. or its subsidiaries. All rights reserved.

Except as expressly provided herein, no part of this manual may be reproduced, copied, transmitted, disseminated, downloaded or stored in any storage medium, for any purpose without the express written permission of Garmin. Garmin hereby grants permission to download a single copy of this manual and of any revision to this manual onto a hard drive or other electronic storage medium to be viewed for personal use, provided that such electronic or printed copy of this manual or revision must contain the complete text of this copyright notice and provided further that any unauthorized commercial distribution of this manual or any revision hereto is strictly prohibited.

Garmin® is a registered trademarks of Garmin Ltd. or its subsidiaries. These trademarks may not be used without the express permission of Garmin.

## **SOFTWARE VERSION**

This manual reflects the operation of System Software version 2.10, or later. Some differences in operation may be observed when comparing the information in this manual to later software versions.

## **INFORMATION & SUPPORT**

For information regarding the [Aviation Limited Warranty](#), refer to Garmin's website.

For aviation product support, visit [flyGarmin.com](http://flyGarmin.com).





### **WARNING**

**FOR SAFETY REASONS, GTR 225 OPERATIONAL PROCEDURES MUST BE LEARNED ON THE GROUND.**



### **CAUTION**

*THE GARMIN GTR 225 DOES NOT CONTAIN ANY USER-SERVICEABLE PARTS. REPAIRS SHOULD ONLY BE MADE BY AN AUTHORIZED GARMIN SERVICE CENTER. UNAUTHORIZED REPAIRS OR MODIFICATIONS COULD VOID BOTH THE WARRANTY AND THE PILOT'S AUTHORITY TO OPERATE THIS DEVICE UNDER FAA/FCC REGULATIONS.*



### **CAUTION**

*THE GTR 225 USES A DISPLAY COATED WITH A SPECIAL ANTI-REFLECTIVE COATING THAT IS VERY SENSITIVE TO SKIN OILS, WAXES, AND ABRASIVE CLEANERS. CLEANERS CONTAINING AMMONIA WILL HARM THE ANTI-REFLECTIVE COATING. IT IS VERY IMPORTANT TO CLEAN THE DISPLAY USING A CLEAN, LINT-FREE CLOTH AND AN EYEGLASS LENS CLEANER THAT IS SPECIFIED AS SAFE FOR ANTI-REFLECTIVE COATINGS.*



### **NOTE**

Do not use outdated database information. Databases used in the system must be updated regularly in order to ensure that the information remains current. Pilots using an outdated database do so entirely at their own risk.



### **NOTE**

Garmin recommends that if flying in a region with 8.33 kHz COM channel spacing, the radio should remain in 8.33 kHz mode. This will prevent the loss of stored user and recent frequencies.



### **NOTE**

All visual depictions contained within this document, including screen images of the GTR 225 bezel and displays, are subject to change and may not reflect the most current GTR 225 software. Depictions of equipment may differ slightly from the actual equipment.



### **NOTE**

This device complies with part 15 of the FCC Rules. Operation is subject to the following two conditions: (1) this device may not cause harmful interference, and (2) this device must accept any interference received, including interference that may cause undesired operation.

## Warnings, Cautions, and Notes



### NOTE

This product, its packaging, and its components contain chemicals known to the State of California to cause cancer, birth defects, or reproductive harm. This notice is being provided in accordance with California's Proposition 65. If you have any questions or would like additional information, please refer to our website at [www.garmin.com/prop65](http://www.garmin.com/prop65).



### NOTE

Canadian installations: In accordance with Canadian Radio Specifications Standard 102 (RSS 102), RF field strength exposure to persons from an antenna connected to this device should be limited to 60 V/m for controlled environment and 28 V/m for uncontrolled environment.



### NOTE

The COM transceiver antenna(s) of the equipment mount along the fuselage and are accessible only to aircraft maintenance personnel.

NOTE: This device complies with Part 15 of the FCC limits for Class B digital devices. This equipment generates, uses, and can radiate radio frequency energy and, if not installed and used in accordance with the instructions, may cause harmful interference to radio communications. Furthermore, there is no guarantee that interference will not occur in a particular installation.

If this equipment causes harmful interference, the user is encouraged to try to correct the interference by relocating the equipment or connecting the equipment to a different circuit other than the affected equipment. Consult an authorized dealer or other qualified avionics technician for additional assistance if these remedies do not correct the problem.

Operation of this device is subject to the following conditions: (1) This device may not cause harmful interference. (2) This device must accept any interference received, including interference that may cause undesired operation.

To obtain accessories for your unit, please contact your Garmin dealer.

The display surface is coated with a special anti-reflective material, which is very sensitive to skin oils, waxes, and abrasive cleaners. It is very important to clean the display using an eyeglass lens cleaner which is specified as safe for anti-reflective coatings and a clean, lint-free cloth.

## Product Registration and Support

Help us better support you by completing your online registration today! Have the serial number of your product handy and connect to the Garmin website ([www.garmin.com](http://www.garmin.com) or <https://fly.garmin.com/fly-garmin>). Look for the Product Registration link on the Home page. Also, be sure to record your serial number in the space provided.

For aviation product support, visit [flyGarmin.com](http://flyGarmin.com).

## Record of Revision

PART NUMBER	REVISION	DATE	CHANGE DESCRIPTION
190-01182-00	A	11/19/12	Initial Release.
	B	03/30/15	Added v2.10 functionality.
	C	10/05/20	Added COM transceiver note and removed support phone numbers.
	D	10/21/20	Updated images on page 3-14.

INTENTIONALLY LEFT BLANK

<b>1 GETTING STARTED .....</b>	<b>1-1</b>
1.1 Product Description .....	1-1
1.2 Pilot Controls .....	1-2
1.3 USB Port .....	1-3
<b>2 COM RADIO BASIC OPERATION .....</b>	<b>2-1</b>
2.1 Selecting a COM Frequency .....	2-1
2.2 Monitoring the Standby COM Channel .....	2-2
2.3 Saving a COM Channel .....	2-2
2.4 COM Database Look-Up .....	2-4
2.5 Emergency Channel .....	2-5
2.6 Stuck Mic .....	2-5
2.7 Frequency Database Reverse Look-Up .....	2-5
2.8 Remote Frequency Selection Control .....	2-6
<b>3 FUNCTIONS .....</b>	<b>3-1</b>
3.1 Functions .....	3-1
3.2 COM Frequencies .....	3-2
3.2.1 Recent COM Frequencies .....	3-2
3.2.2 COM User Frequencies .....	3-2
3.2.3 COM Database Frequencies .....	3-4
3.2.4 COM Nearest Airports (APT) .....	3-5
3.2.5 COM Nearest Area Control Center (ACC) Frequencies .....	3-5
3.2.6 COM Nearest Flight Service Station (FSS) Frequencies .....	3-6
3.2.7 COM Nearest Weather (WX) Frequencies .....	3-6
3.3 ICS Configuration .....	3-7
3.3.1 Adjust Intercom .....	3-7
3.3.2 AUX Audio .....	3-8
3.3.3 Intercom On/Off .....	3-8
3.3.4 Speaker On/Off .....	3-9
3.4 System Configuration .....	3-10
3.4.1 COM Spacing .....	3-10
3.4.2 COM Sidetone (Software v2.10 or later) .....	3-11
3.4.3 Display Brightness .....	3-12
3.4.4 Display Contrast .....	3-12
3.4.5 Database Info .....	3-13
3.4.6 Load Database .....	3-13
3.4.7 Software Version .....	3-14
3.4.8 Serial Number .....	3-14
3.5 Timers .....	3-15
3.5.1 Setting Up the Count Down Timer .....	3-15
3.5.2 Setting Up the Count Up Timer .....	3-15
3.5.3 Viewing Timers in the COM Display .....	3-16
<b>4 DATABASE INFORMATION .....</b>	<b>4-1</b>
4.1 Downloading the Frequency Database .....	4-1
4.2 Updating the GTR 225 Frequency Database .....	4-1
<b>5 TROUBLESHOOTING .....</b>	<b>5-1</b>
5.1 Messages .....	5-3

INTENTIONALLY LEFT BLANK



# 1 Getting Started

## 1.1 Product Description

The GTR 225 COM Radio series provides a powerful VHF communications transceiver. In addition to the traditional COM features, the GTR 225 series incorporates workload-reducing functions.

The GTR 225 series monitors the standby COM frequencies and stores the user's most-used frequencies. The GTR 225 (10 watt) COM radio operates in the aviation voice band, from 118.000 to 136.975 MHz, in 25 kHz steps (default). For European operations, configuration for 8.33 kHz steps is provided with the GTR 225A (10 watt) and GTR 225B (16 watt).

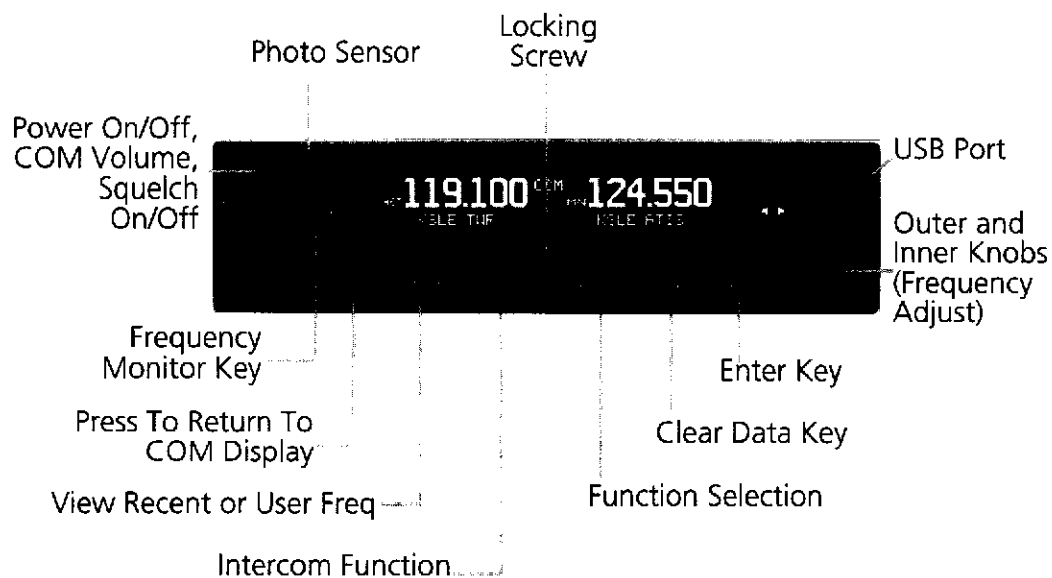

**GTR 225 Front Panel Description**

## Getting Started

# 1.2 Pilot Controls

The GTR 225 controls are designed to simplify systems operation, minimize workload, and reduce time required to access functionality. Controls are comprised of dual knobs for frequency tuning, COM volume/squelch knob, and bezel keys.

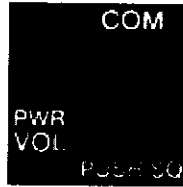

### Power/COM Volume/Squelch Knob

The **Power/COM Volume/Squelch** knob located in the top left corner of the bezel controls audio volume for the COM radio. To power on, turn the knob clockwise past detent. Turn the knob counterclockwise to power off. When the COM radio is active, press the **Power/COM Volume/Squelch** knob to toggle automatic squelch control On/Off for the COM radio.

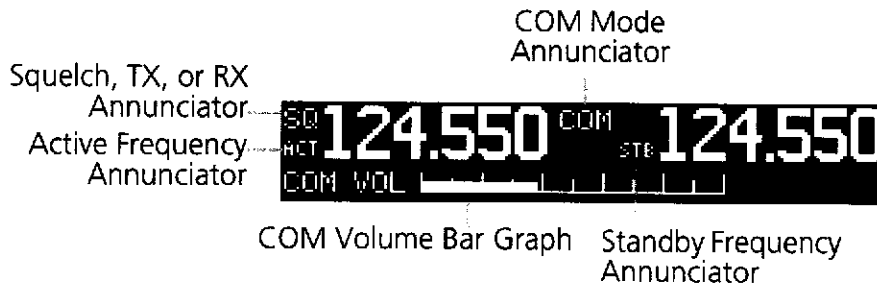

### COM Volume and Squelch Display

The COM radio has an automatic squelch to reject many localized noise sources. You may override the squelch function by pressing the **Power/COM Volume/Squelch** knob. This facilitates listening to a distant station or setting the desired volume level.

To override the automatic squelch, press the **Power/COM Volume/Squelch** knob momentarily. Press the **Power/COM Volume/Squelch** knob again to return to automatic squelch operation. When the automatic squelch is overridden, an "SQ" indicator appears in the upper left corner of the display, left of the active COM frequency window.

The outer right and inner right knobs are used for tuning frequencies and data entry.

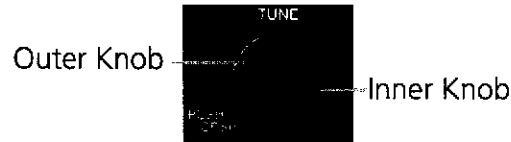

To switch between the active (left-most) and standby (right-most) frequency press and release the **FLIP/FLOP** key. Switching between COM frequencies is disabled when transmitting.



To return to the COM radio mode press the **COM** key.



To recall and toggle between the COM Recent and User Frequency lists press the **MEM** key.



To toggle display of the ICS settings for Intercom On/Off, AUX Audio, or the Intercom settings press the **ICS** key.



To erase information, cancel entries, and reset timers press the **CLR** key.



To save selected values, to confirm a prompt, or to save the standby frequency press the **ENT** key.



The **FUNC** (Function) key accesses function categories for the COM Radio, ICS Configuration, System Configuration, and Timer. Pressing the **FUNC** key once displays the Function mode. Pressing the **FUNC** key a second time exits the Function mode.



The **MON** (Monitor) key engages the monitor function. The standby frequency can be monitored while still listening to the active frequency.

## 1.3 USB Port

The USB port is used to update the frequency database in the GTR 225.



### NOTE

For updating the databases, Garmin recommends the use of a USB 2.0 compatible flash drive. The flash drive must be formatted as FAT32.

INTENTIONALLY LEFT BLANK

# 2 COM Radio Basic Operation

## 2.1 Selecting a COM Frequency

New frequencies are first selected as a standby frequency and then toggled to the active side with the **FLIP/FLOP** key. While viewing the standby frequency display, use the outer and inner knobs on the right side of the GTR 225 to select the desired frequency.

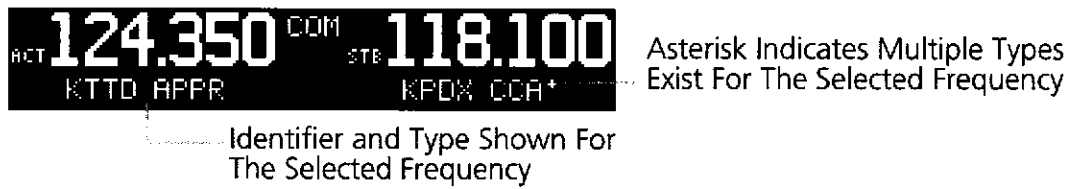

### COM Frequency Selection

1. Press **COM**, if necessary, to reach the COM radio function. The COM annunciator on the top line of the display will show.
2. Turn the outer knob to change the values in one MHz increments. The MHz selection range is between 118 and 136 in one MHz steps.
3. Turn the inner knob to change the values in 25 kHz or 8.33 kHz increments. The kHz selection range is between 000 and 975 kHz in 25 kHz steps or 000 and 990 kHz in 8.33 kHz steps.
4. Turn the outer and inner knobs clockwise to increase and counterclockwise to decrease the frequency values. Standby frequency selection is not inhibited during transmit.
5. When connected to a position source, the nearest station identifier will be shown for the selected frequency. Frequencies with multiple types will have an asterisk next to the identifier.
6. Press and release the **FLIP/FLOP** key to toggle the standby frequency to the active frequency.

## 2.2 Monitoring the Standby COM Channel



### COM Frequency Monitor Annunciation

The Frequency Monitoring function allows you to monitor the standby frequency for activity, while listening to the active frequency.

Press the **MON** key in the COM function to listen to the standby frequency. A small "MN" will replace the "STB" to the left of the standby frequency.

When the active frequency receives a signal, the unit will switch automatically to the active frequency. The active frequency quality is not affected. The Frequency Monitor function is turned off by pressing the **MON** key again.

## 2.3 Saving a COM Channel

The current standby frequency may be saved into the COM User Frequency database from the COM display or the COM User Function. The COM User Frequency database can hold up to fifteen frequencies.



### NOTE

When switching from 8.33 kHz to 25 kHz mode, any 8.33 kHz-specific user frequencies will be deleted from the user frequency list. This only affects the user frequencies within the 8.33 kHz spectrum.



### COM User Frequency Name Selection

1. Press **ENT**.
2. Turn the inner knob to select characters.
3. Turn the outer knob to move the cursor.
4. After selecting characters, press **ENT**.
5. Turn the outer knob to select the waypoint type.
6. Turn the inner knob to select the type from the list.
7. Press **ENT** to save displayed value.  
Press **CLR** to cancel the changes.



Waypoint Type

COM User Frequency Type Selection

COM Frequency Type List

FREQUENCY TYPE SYMBOL	DESCRIPTION
TWR	Tower
GND	Ground
ATIS	Automatic Terminal Information Service
AWS	Automated Weather Observing System
ATF	Aerodrome Traffic Frequency
ARR	Arrival
APPR	Approach
DEP	Departure
CLR	Clearance
CTAF	Common Traffic Advisory Frequency
FSS	Flight Service Station
RFS	Remote Flight Service Station
MF	Mandatory Frequency
UNI	Unicom
Blank	None

## 2.4 COM Database Look-Up

1. Press the inner knob from the COM display to activate the database look-up function.

Identifier Field



### Database Identifier Active for Selection

2. Turn the inner knob to select characters and turn the outer knob to move the cursor.



### Database Identifier Selection

3. After selecting characters, press **ENT**.
4. Turn the inner knob to scroll through the list of waypoint types. Waypoint types with a "+" sign will have more frequencies for the same type. After selection, the selected waypoint and type will be stored for 30 minutes.



### Database Frequency Type Selection

5. Press **ENT** to copy the frequency into the standby frequency location.
6. The nearest station identifier will show for the selected frequency if connected to a GPS position source.
7. Press and release the **FLIP/FLOP** key to swap the active and standby frequencies.



## 2.5 Emergency Channel

Press and hold the **FLIP/FLOP** key or the COM Remote Transfer (**COM RMT XFR**) key for approximately two seconds. The Emergency Channel will be inserted into the active frequency position and the previous active Frequency will become the standby frequency.



### Emergency Channel



#### NOTE

Pressing and holding the COM Remote Transfer (COM RMT XFR) key for approximately two seconds, on units so configured, will lock the COM board, preventing further changes in COM frequency until the COM board is unlocked, by pressing the COM Remote Transfer key again for two seconds. The following message will notify the pilot that the COM board has been locked: "COM LOCKED TO 121.5 MHZ. HOLD REMOTE COM TRANSFER KEY TO EXIT."



#### NOTE

Under some circumstances if the COM system loses communication with the main system, the radio will automatically tune to 121.50 MHz for transmit and receive regardless of the displayed frequency.

## 2.6 Stuck Mic

The GTR 225 helps protect you from a situation where the microphone may get stuck in the ON or Transmit position. If the microphone is keyed for longer than 35 seconds, the GTR 225 will return to the receive mode on the selected frequency.

A "Stuck Mic" message will display until the transmit key is released. Alerts will display until the error clears or the user acknowledges it.

## 2.7 Frequency Database Reverse Look-Up

When the unit is receiving a valid position input, the airport identifier and frequency type will show for the nearest facilities. Waypoint types with a "+" sign will have more frequencies for the same type.

Airport Identifier Shown for  
Frequencies In Database



### Frequency Database Reverse Look-Up

## 2.8 Remote Frequency Selection Control

On units configured for remote COM frequency Recall, pressing the remote recall switch will load the next preset COM frequency into the unit's standby frequency box. The remote recall switch can be pressed multiple times to scroll the entire preset frequency list through the standby frequency box (the list will wrap from the bottom of the list back up to the top, skipping any empty preset positions).

The standby frequency isn't activated until either the bezel-mounted COM **FLIP/FLOP** key or remote **COM RMT XFR** switch is pressed. Remote Frequency Selection only functions on units configured for a remote COM Frequency recall switch.

# 3 Functions

Information about COM Frequencies, ICS Configuration, SYS Configuration, and Timer Configuration is provided in this section.

## 3.1 Functions

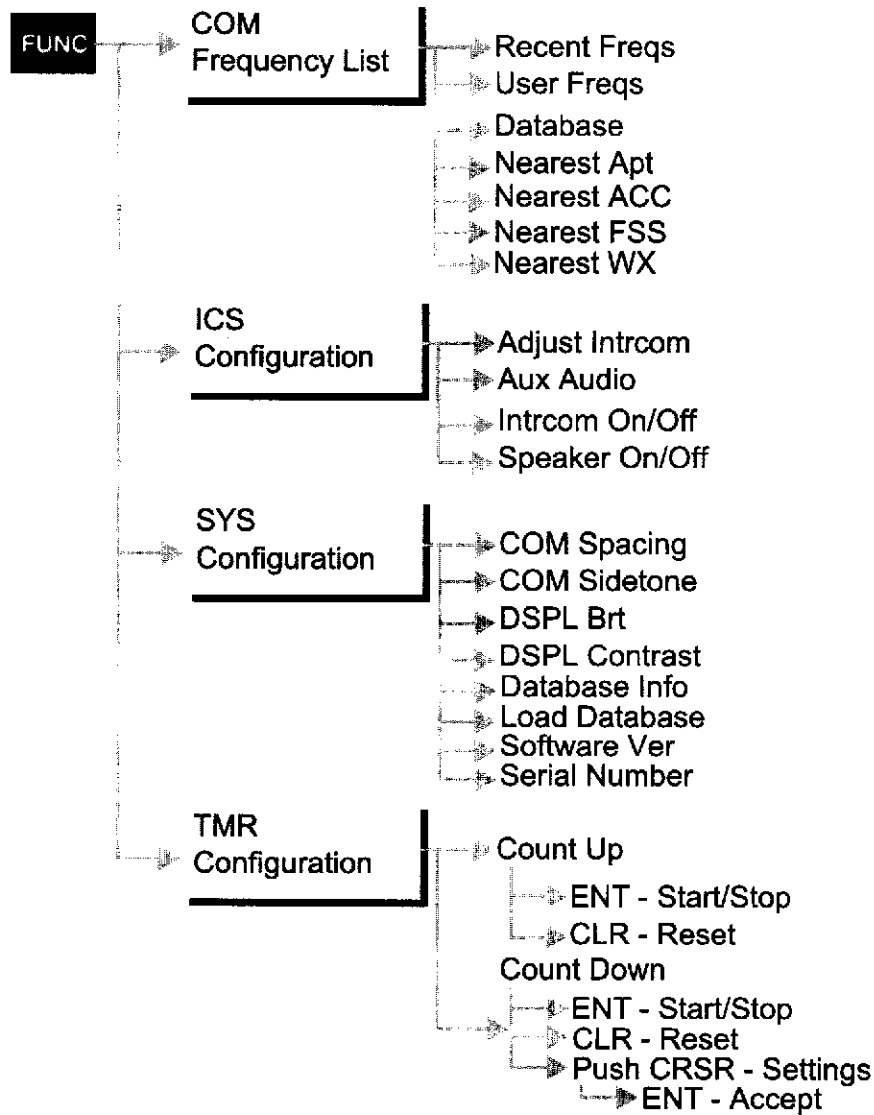

Functions Diagram

## Functions

# 3.2 COM Frequencies

The COM Frequency List contains recently used frequencies (Recent), user-defined frequencies (User), a database of all frequencies provided in the standard default memory (Database), and nearest airport, Area Control Center (ACC), Flight Service Station (FSS), and weather frequencies (WX).

## 3.2.1 Recent COM Frequencies

The last twenty COM frequencies used are kept in the list of recent COM frequencies.



### NOTE

When switching from 8.33 kHz to 25 kHz mode, any 8.33 kHz-specific user frequencies will be deleted from the user frequency list. This only affects the user frequencies within the 8.33 kHz spectrum.



### Recent COM Frequencies

1. Press **MEM**.
2. Turn the inner knob to select an entry (1-20).
3. Press **FLIP/FLOP** to set the selected frequency as the active frequency. Press **ENT** to set the selected frequency as the standby frequency.

## 3.2.2 COM User Frequencies

Fifteen COM user frequencies can be saved with an assigned waypoint (WPT) identifier and type.



### NOTE

When switching from 8.33 kHz to 25 kHz mode, any 8.33 kHz-specific user frequencies will be deleted from the user frequency list. This only affects the user frequencies within the 8.33 kHz spectrum.



Waypoint Name      Waypoint Type

### COM User Frequencies

## Viewing a COM User Frequency

1. Press **FUNC**.
2. Turn the inner knob to USER FREQS.
3. Press **ENT**.
4. Turn the inner knob to cycle through COM user frequencies.
5. Press **FLIP/FLOP** to set the selected frequency as the active frequency.  
Press **ENT** to set the selected frequency as the standby frequency.

## Deleting a COM User Frequency



### Deleting User COM Frequencies

1. Press **FUNC**.
2. Turn the inner knob to USER FREQS.
3. Press **ENT**.
4. Turn the inner knob to cycle through COM user frequencies.
5. Press **CLR** to delete the selected user frequency.
6. Press **ENT** to confirm deleting the selection.

## Editing a COM User Frequency



### COM User Frequency Selection

1. Press **FUNC**.
2. Turn the inner knob to USER FREQS.
3. Press **ENT**.
4. Turn the inner knob to the COM user frequency to edit.
5. Press the inner knob to start editing the COM user frequency.
6. Turn the inner knob to select the MHz values.
7. Turn the outer knob to select the kHz field.
8. Turn the inner knob to select the kHz values.
9. Turn the outer knob to select the WPT field.
10. Turn the inner knob to select characters and turn the outer knob to move the cursor.

## Functions



Waypoint Name

### COM User Frequency Name Selection

11. Press **ENT**.
12. Turn the outer knob to select the TYPE field.
13. Turn the inner knob to select the waypoint type.



Waypoint Type

### COM User Frequency Type Selection

14. Press **ENT** to accept changes.  
Press **CLR** to cancel changes.

## 3.2.3 COM Database Frequencies

The GTR 225 contains a database of COM frequencies that may be recalled by identifier.



Character

### COM Database Frequencies

1. Press **FUNC**.
2. Turn the inner knob to DATABASE.
3. Press **ENT**.
4. Turn the inner knob to select the character.
5. Turn the outer knob to move the cursor to highlight a character.
6. Press **ENT**.
7. If the frequency type is available, turn the inner knob to select the frequency type.
8. Press **FLIP/FLOP** to set the selected frequency as the active frequency.  
Press **ENT** to set the selected frequency as the standby frequency.



### NOTE

The nearest station identifier for the selected frequency will be shown below the active or standby frequency, when connected to a GPS position source.

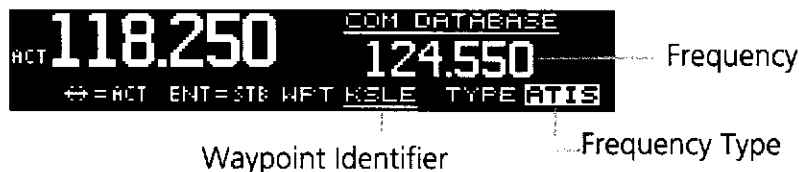

**Selected COM Database Frequency**

### 3.2.4 COM Nearest Airports (APT)

When interfaced with a GPS receiver, the GTR 225 will report the twenty-five nearest airports (APT).



**COM Nearest Airport Frequencies**

1. Press **FUNC**.
2. Turn the inner knob to NEAREST APT.
3. Press **ENT**.
4. Turn the inner knob to scroll through the list of available APT frequencies.
5. Press **FLIP/FLOP** to set the selected frequency as the active frequency.  
Press **ENT** to set the selected frequency as the standby frequency.  
Press **CLR** to return to the functions display.

### 3.2.5 COM Nearest Area Control Center (ACC) Frequencies

When interfaced with a GPS receiver, the GTR 225 will report the twenty-five nearest Area Control Center (ACC) frequencies. ACCs are also known as Air Route Traffic Control Centers (ARTCC).



**COM Nearest Area Control Center Frequencies**

1. Press **FUNC**.
2. Turn the inner knob to NEAREST ACC.
3. Press **ENT**.
4. Turn the inner knob to scroll through the list of available ACC frequencies.
5. Press **FLIP/FLOP** to set the selected frequency as the active frequency.  
Press **ENT** to set the selected frequency as the standby frequency.  
Press **CLR** to return to the functions display.

## Functions

### 3.2.6 COM Nearest Flight Service Station (FSS) Frequencies

When interfaced with a GPS receiver, the GTR 225 will report the twenty-five nearest Flight Service Station (FSS) frequencies.



#### COM Nearest Flight Service Station Frequencies

1. Press **FUNC**.
2. Turn the inner knob to NEAREST FSS.
3. Press **ENT**.
4. Turn the inner knob to scroll through the list of available FSS frequencies.
5. Press **FLIP/FLOP** to set the selected frequency as the active frequency.  
Press **ENT** to set the selected frequency as the standby frequency.  
Press **CLR** to return to the functions display.

### 3.2.7 COM Nearest Weather (WX) Frequencies

When interfaced with a GPS receiver, the GTR 225 will report the twenty-five nearest weather (WX) frequencies.



#### COM Nearest Weather Frequencies

1. Press **FUNC**.
2. Turn the inner knob to NEAREST WX.
3. Press **ENT**.
4. Turn the inner knob to scroll through the available weather frequencies.
5. Press **FLIP/FLOP** to set the selected frequency as the active frequency.  
Press **ENT** to set the selected frequency as the standby frequency.  
Press **CLR** to return to the functions display.



## 3.3 ICS Configuration

ICS Configuration adjusts the intercom, sets the AUX audio, and turns the intercom and speaker on or off.

### 3.3.1 Adjust Intercom

The Adjust Intercom function sets the values for the intercom squelch, intercom volume, and sets the intercom audio to mute when COM transmissions are received. The Intercom On/Off function must be set to ON to make the Adjust Intercom function available.



#### NOTE

To enable ICS auto squelch, turn the knob one click counterclockwise past 0. When squelch is set to auto, the squelch sensitivity adjusts automatically. When squelch is set to 0, squelch is usually open. When squelch is set to 100, squelch is usually closed. ICS auto squelch is available with software v2.10 or later.

#### Intercom Squelch



#### Adjust Intercom Settings

1. Press **ICS**.
2. Turn the inner knob to set the ICS squelch (SQ) value.
3. Turn the outer knob to move to ICS volume (VOL) field.
4. Turn the inner knob to set the ICS volume level.
5. Turn outer knob to MUTE ON RX (software v2.10 or later).
6. Turn inner knob to ON or OFF. To mute when a radio transmission is received, select ON.
7. Press **ENT** to save changes.  
Press **CLR** to cancel the changes.

## Functions

### 3.3.2 AUX Audio

The AUX Audio function turns AUX Audio on or off, sets the AUX volume level, and sets the AUX audio to mute when a COM radio transmission is received.

#### AUX Audio Status



#### Adjust AUX Audio

1. Press **FUNC**.
2. Turn the outer knob to ICS CONFIGURATION.
3. Turn the inner knob to AUX AUDIO.
4. Press **ENT**.
5. Turn the inner knob to turn the AUX audio ON or OFF.
6. Turn the outer knob to VOL.
7. Turn the inner knob to set the AUX volume level.
8. Turn the outer knob to MUTE ON RX (available with software v2.10 or later).
9. Turn the inner knob to ON or OFF. To mute the AUX audio when a radio transmission is received, select ON.
10. Press **ENT** to save new values.  
Press **CLR** to cancel the changes.

### 3.3.3 Intercom On/Off

The Intercom On/Off function toggles the intercom on and off. If installed with a remote switch, the intercom can also be remotely toggled on or off. The Intercom On/Off function must be set to ON to make the Adjust Intercom function available.



#### Intercom On/Off

1. Press **FUNC**.
2. Turn the outer knob to ICS CONFIGURATION.
3. Turn the inner knob to INTRCOM ON/OFF.
4. Press **ENT**.
5. Turn the inner knob to set the Intercom ON or OFF.
6. Press **ENT** to save the selected value.  
Press **CLR** to cancel the change.

### 3.3.4 Speaker On/Off

The Speaker On/Off function toggles the speaker output on and off.

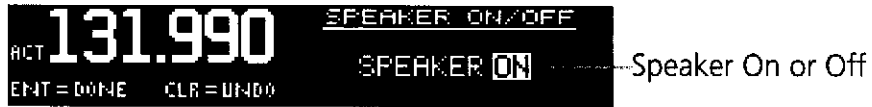

#### Speaker On/Off

1. Press **FUNC**.
2. Turn the outer knob to ICS CONFIGURATION.
3. Turn the inner knob to SPEAKER ON/OFF.
4. Press **ENT**.
5. Turn the inner knob to set the speaker output ON or OFF.
6. Press **ENT** to save the selected value.  
Press **CLR** to cancel the change.

## Functions

# 3.4 System Configuration

The System Configuration function displays the software version, database information, and serial number. This information is helpful when contacting customer support. It also allows setting the COM spacing, display brightness and contrast, and to update databases.

## 3.4.1 COM Spacing

COM spacing may be selected between 8.33 kHz and 25 kHz to allow for regional requirements.



### NOTE

When switching from 8.33 kHz to 25 kHz mode, any 8.33 kHz-specific user frequencies will be deleted from the user frequency list. This only affects the user frequencies within the 8.33 kHz spectrum.



Channel Spacing

### COM Spacing

1. Press **FUNC**.
2. Turn the outer knob to **SYS CONFIGURATION**.
3. Turn the inner knob to **COM SPACING**.
4. Press **ENT**.
5. Turn the inner knob to set the COM spacing.
6. Press **ENT** to save the selected value.  
Press **CLR** to cancel the change.

### 3.4.2 COM Sidetone (Software v2.10 or later)

COM sidetone is the audio spoken into the COM microphone. This setting affects the volume of the sidetone in the headsets for the COM during PTT. The COM Sidetone Offset adjusts the amount that the COM sidetone volume level is offset from the COM receiver volume level. The range can be adjusted from -10 (lowest) to 10 (highest), with 0 as the default.



#### NOTE

COM Sidetone Pilot Control must be enabled by the installer.



#### COM Sidetone Page

1. Press **FUNC**.
2. Turn the outer knob to **SYS CONFIGURATION**.
3. Turn the inner knob to **COM SIDETONE**.
4. Press **ENT**.
5. Turn the inner knob to set mode of COM sidetone.  
**OFFSET**: COM sidetone volume changes with adjustments of the COM volume knob.  
**FIXED**: COM sidetone volume is at level set at installation.
6. If offset mode is selected, turn the outer knob to **OFFSET**.
7. Turn the inner knob to set the offset value.
8. Press **ENT** to save selected values.  
 Press **CLR** to cancel the changes.

## Functions

### 3.4.3 Display Brightness

From the factory, the GTR 225 automatically adjusts its display brightness for the current lighting conditions. A small sensor on the display is used for this function. A manual adjustment is available for controlling the brightness level of the display as an offset from the normal or zero position.

The limits of the adjustment range are: -10 (Low Display Intensity) and 100 (High Display Intensity). A value above zero means brighter than normal and a value below zero means darker than normal. The range can be adjusted by using the inner knob.

The GTR 225 will either control dimming based on the photocell or the lighting bus. This is set in configuration mode during installation and is not selectable by the pilot.



#### Display Brightness Page

1. Press **FUNC**.
2. Turn the outer knob to **SYS CONFIGURATION**.
3. Turn the inner knob to **DSPL BRT**.
4. Press **ENT**.
5. Turn the inner knob to set the value.
6. Press **ENT** to save selected value.  
Press **CLR** to cancel change.

### 3.4.4 Display Contrast

The display contrast has a range from -50 (low) and 50 (high) with 0 as the default. The range can be adjusted by using the inner knob.



#### Display Contrast Page

1. Press **FUNC**.
2. Turn the outer knob to **SYS CONFIGURATION**.
3. Turn the inner knob to **DSPL CONTRAST**.
4. Press **ENT**.
5. Turn the inner knob to set the offset value.
6. Press **ENT** to save selected value.  
Press **CLR** to cancel the change.

### 3.4.5 Database Info

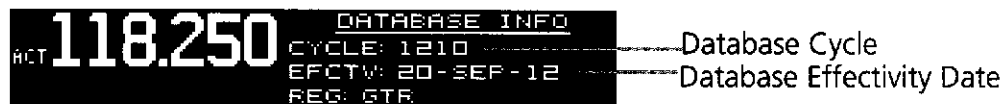

#### Database Info Page

1. Press **FUNC**.
2. Turn the outer knob to SYS CONFIGURATION.
3. Turn the inner knob to DATABASE INFO.
4. Press **ENT**.
5. Press the **FUNC** to exit page.

### 3.4.6 Load Database

The GTR 225 has a USB port to allow for easily updating the system databases.



#### NOTE

Garmin recommends the use of a USB 2.0 compatible USB flash drive, formatted as FAT32, for updating the database.

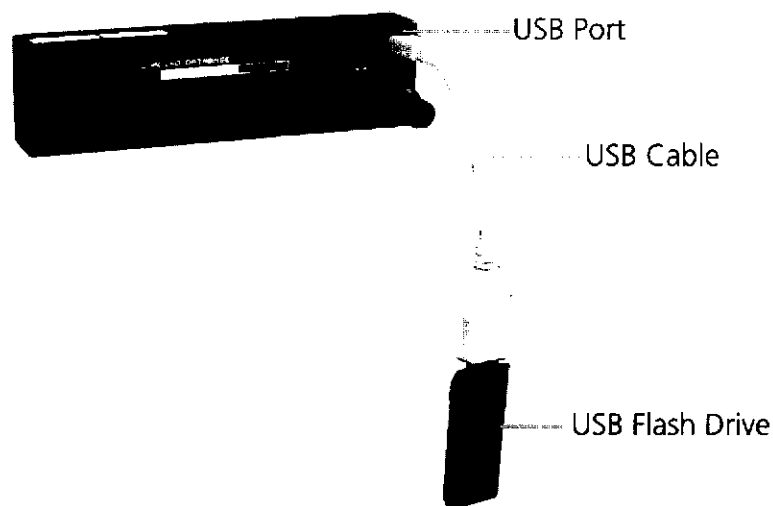

1. Insert the supplied cable into the USB port of the GTR 225.
2. Insert the USB flash drive into the other end of the cable.
3. Press **FUNC**.
4. Turn the outer knob to SYS CONFIGURATION.
5. Turn the inner knob to LOAD DATABASE.
6. Press **ENT**.



#### Database Update Page

## Functions

7. Verify the database version on flash drive.



Version On Unit      Version On Flash

### Database Version Page

8. Press **ENT** to begin update.
9. Wait until the updating process is complete, then verify the correct database is loaded onto the unit.

## 3.4.7 Software Version



Display Software Version  
COM Software Version

### Software Version Page

1. Press **FUNC**.
2. Turn the outer knob to SYS CONFIGURATION.
3. Turn the inner knob to SOFTWARE VER.
4. Press **ENT**.
5. Press **FUNC** to return to the main menu.

## 3.4.8 Serial Number



### NOTE

The ID consists of a combination of numbers 0-9 and letters A-F. The number 8 and the letter B are distinguishable as depicted in the Serial Number screenshot.

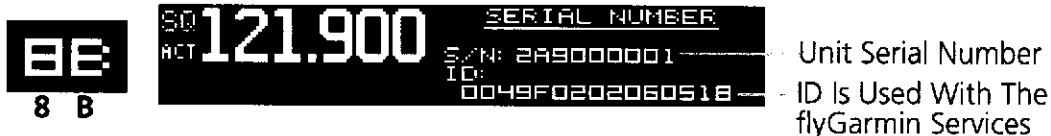

Unit Serial Number  
ID Is Used With The  
flyGarmin Services

### Serial Number Page

1. Press **FUNC**.
2. Turn the outer knob to SYS CONFIGURATION.
3. Turn the inner knob to SERIAL NUMBER.
4. Press **ENT**.
5. Press **FUNC** to return to the main menu.



## 3.5 Timers

The GTR 225 has both count up and count down timers, which may operate simultaneously, and are shown in the lower right of the COM displays. The countdown timer always takes precedence if it is running.

### 3.5.1 Setting Up the Count Down Timer



1. Press **FUNC**.
2. Turn the outer knob to TMR CONFIGURATION.
3. Turn the inner knob to COUNT DOWN.
4. Press **ENT**.
5. Press the inner knob to enter a starting timer value.
6. Turn the outer knob to move to set seconds, minutes, or hours.
7. Press **ENT** to confirm entry.
8. Press **ENT** to start or stop the timer.
9. Press the **CLR** key to reset the timer to the starting value.
10. Press the inner knob to change the starting timer value.

### 3.5.2 Setting Up the Count Up Timer



1. Press **FUNC**.
2. Turn the outer knob to TMR CONFIGURATION.
3. Turn the inner knob to COUNT UP.
4. Press **ENT**.
5. Press the **ENT** key to start the timer.
6. Press the **ENT** key again to stop the timer.
7. Press the **CLR** key to reset the timer to 0:00 and stop counting.

## Functions

### 3.5.3 Viewing Timers in the COM Display

When a timer is active, the timer value will be shown in the lower right corner of the COM display. While both timers may be actively counting at the same time, the count down timer will have precedence in being shown. If the count down timer is paused, the count up timer will then be shown until the count down timer is restarted.



Timer Value Shown in the COM Display

### Clearing and Stopping Displayed Timers



#### Clearing and Stopping Timers

1. To reset the timer, press **CLR** and then **ENT**.
2. To stop the displayed timer, press **ENT** twice.

When the count down timer reaches 0:00, it will continue counting as a count up timer. The count down timer, which is counting up, will be highlighted. A count up timer will continue counting separately.



COM Display with Count Down Timer Now Counting Up

# 4 Database Information



## NOTE

The data contained in the frequency database comes from government agencies. Garmin accurately processes and cross-validates the data, but cannot guarantee the accuracy and completeness of the data.

The GTR 225 uses a standard USB flash drive to load the frequency database into the GTR 225. The flash drive is not provided by Garmin. The frequency database is stored internally and the USB flash drive is only used to transfer the database into the unit.

The following equipment is required to perform the update:

- Windows-compatible PC computer (Windows 2000, XP, Vista, or Windows 7 recommended)
- USB 2.0 compatible USB flash drive formatted as FAT32
- External USB cable
- Updated database obtained from the Garmin website

## 4.1 Downloading the Frequency Database



## NOTE

The GTR 225's system ID is required when downloading the frequency database. See section 3.4.8 for details on the system ID.

The Garmin databases can be updated by following the instructions on <https://fly.garmin.com/fly-garmin>. The frequency database is updated on a 28-day cycle.

## 4.2 Updating the GTR 225 Frequency Database

See section 3.4.6 for details on loading the database into the GTR 225.

INTENTIONALLY LEFT BLANK

# 5 Troubleshooting

If efforts to resolve the problem are not successful, contact your dealer or the factory for technical assistance. Please have the following information ready:

- System configuration (products, antennas, mounting locations, etc.)
- Model number, part number, and serial number
- Software versions
- Description of the problem
- Efforts made to isolate/solve the problem

For aviation product support, visit [flyGarmin.com](http://flyGarmin.com).

## Troubleshooting

PROBLEM	POSSIBLE CAUSE	ACTION
GTR 225 does not power on	No power to the GTR 225.	Check power connections, breakers, and main avionics switch.
	Faulty electrical wiring or connection.	Contact your dealer to perform electrical system test.
GTR 225 does not transmit	No power to COM.	Check power connections.
	Mic key connection	Check Mic key input connection.
Intercom doesn't function	It can be enabled or disabled via a remote mounted switch or via the menu.	Check connections.
	No voice activation, or if must talk too loud.	Check ICS page, Intercom On/Off, Adjust Intercom.
Unable to change active frequency	COM Radio not communicating. The radio may also be in lockout mode. In this case the radio would be tuned to 121.50 and the active freq would not be able to be changed.	If in Lock Out mode, press the external COM FLIP/FLOP key for two seconds to return to normal operation or cycle the avionics power. If the condition persists, contact dealer.
Display shows "COM Radio Needs Service" at start-up	Corrupted system calibration parameters	Contact factory.

## 5.1 Messages

When a message has been issued by the unit, the message will be shown on the display. After viewing the messages, press the **ENT** key to acknowledge the message and return to the previously viewed page. An acknowledged message will not be redisplayed even if the condition persists. Messages provide an aid to troubleshooting system operation.

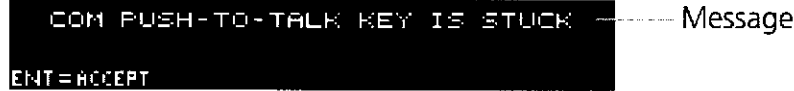

### Display of Message

#### Messages

MESSAGE	DESCRIPTION	ACTION
<b>COM RADIO -</b> COM radio needs service.	The COM radio is reporting that it needs service. The COM radio may continue to function.	Cycle the power to the COM radio. Contact dealer for service.
<b>COM RADIO -</b> COM radio may be inoperative.	The COM radio is not communicating properly with the system.	Press and hold the volume knob or the external COM remote transfer (COM RMT XFR) switch, if installed – this will force the COM radio to 121.5 MHz. Contact dealer for service.
<b>COM RADIO -</b> COM overtemp or undervoltage. Reducing transmitter power.	COM radio is in overtemp or undervoltage mode and transmitting power has been reduced to prevent damage to the COM radio. Radio range will be reduced.	Decrease length of COM transmissions, decrease cabin temperature and increase cabin airflow (especially near the GTR). Check aircraft voltage and reduce electrical load as necessary. Contact dealer for service if this message persists.
<b>COM RADIO -</b> COM locked to 121.5 MHz. Hold remote COM transfer key to exit.	COM radio is locked to 121.5 MHz.	The external COM remote transfer (COM RMT XFR) switch has been held and the COM radio is tuned to 121.5. To exit this mode, hold the COM remote transfer (COM RMT XFR) switch for two seconds.

## Troubleshooting

MESSAGE	DESCRIPTION	ACTION
<b>COOLING FAN -</b> The cooling fan has failed.	The GTR cooling fan is powered, but it is not turning at the desired RPM.	Decrease cabin temperature and increase cabin airflow (especially near the GTR) to prevent damage to the unit. Contact dealer for service.
<b>DISPLAY -</b> Display board needs service.	The display board is indicating that it needs service.	Contact dealer for service.
<b>FEATURE UNLOCK FAILURE -</b>	The database on the USB flash drive is corrupt or the system ID in the database does not match the unit's system ID.	Verify that the correct system ID is entered into flyGarmin.com when downloading the database. Contact Garmin Customer Support if this message persists.
<b>NO UNLOCK FILE -</b>	The USB flash drive is missing the feature unlock file for the frequency database.	Verify the correct system ID is entered on flyGarmin.com and the frequency database is downloaded onto the USB flash drive. Contact Garmin Customer Support if this message persists.



### NOTE

The GTR 225's system ID is required when downloading the frequency database. See section 3.4.8 for details on the system ID.



MESSAGE	DESCRIPTION	ACTION
<p><b>POWER ALERT -</b> Unit will shut down if power switch is not restored immediately.</p>	<p>Power has been removed from the unit.</p>	<p>Re-apply power to the unit.</p>
<p><b>REMOTE KEY STUCK -</b> COM push-to-talk key is stuck.</p>	<p>The Push To Talk key/switch has been in pressed position for at least 30 seconds. This input will now be ignored and the COM radio will no longer transmit.</p>	<p>Verify the Push To Talk key/switch is not stuck. Contact dealer for service if this message persists.</p>
<p><b>REMOTE KEY STUCK -</b> COM remote transfer key is stuck.</p>	<p>The remote COM transfer (COM RMT XFR) key/switch has been in pressed position for at least 30 seconds. This input will now be ignored. This input is not available in all installations.</p>	<p>Verify the COM RMT XFR key/switch is not stuck. Contact dealer for service if this message persists.</p>
<p><b>REMOTE KEY STUCK -</b> COM remote frequency increment key is stuck.</p>	<p>The remote COM frequency increment (COM CHAN UP) key/switch has been in pressed position for at least 30 seconds. This input will now be ignored. This input is not available in all installations.</p>	<p>Verify the COM CHAN UP key/switch is not stuck. Contact dealer for service if this message persists.</p>
<p><b>REMOTE KEY STUCK -</b> COM remote frequency decrement key is stuck.</p>	<p>The remote COM frequency decrement (COM CHAN DN) key/switch has been in pressed position for at least 30 seconds. This input will now be ignored. This input is not available in all installations.</p>	<p>Verify the COM CHAN DN key/switch is not stuck. Contact dealer for service if this message persists.</p>

INTENTIONALLY LEFT BLANK





190-01182-00 Rev. D